



K56 CLEVELAND/ TUDOR - LED

One of the most versatile of all ornamental luminaires available in the first half of the 20th century, the K56 Cleveland/Tudor offers the beauty of yesteryear with the superior LED lighting performance standards of today. Available without spurs (Cleveland) or with spurs (Tudor). Add to the continuity of your space with a matching pendant to light pathways and roadways alike.



King Luminaire

PRODUCT SPECIFICATIONS

P4 LED ENGINE

Light engine shall include an array of Cree X-Series high power LEDs (light emitting diodes). The emitters shall be mounted to a metal core circuit board using SMT technology. The LEDs and circuit boards shall then be mounted to a high performance heat sink.

External light control shall consist of high precision refractive lenses mounted above the LED emitter arrays in such a way to achieve optimum uplight control. The lenses shall also control horizontal light distribution so that either Type II, III, IV or V IESNA distribution patterns are achieved.

LENS

The lens panels shall be made of polycarbonate or acrylic. The polycarbonate shall be a minimum of 3/16" thick and composed of Bayer Makrolon LTG 3123, General Electric Lexan 243, or equivalent. The acrylic shall be a minimum of 3/16" thick and composed of AtoHaas V825-UVA5A, ICI CP-75-UVA, Cyro S-10-343, or equivalent. This is available in either clear or rippled configurations.

LUMINAIRE CONSTRUCTION

All K56 Cleveland/Tudor cast components shall consist of a heavy cast aluminum. The main body or capital, acts as an enclosure for the driver assembly and is of adequate thickness to give sufficient structural rigidity. The T-Style, K16 and K24 capital shall have an opening at the base tenon body to allow the luminaire to be mounted to a tenon of 3-1/2" maximum diameter. The R-Style, K5 and K6 capital lock to a 7" OD post top ring. The luminaire shall be locked in place by means of heavy duty, stainless-steel set-screws.

LUMINAIRE ASSEMBLY

The luminaire assembly is a self-contained unit consisting of a rugged cast aluminum body, and the LED light engine consisting of aluminum castings and the LED light engine. The LED light engine is of a modular design, and is able to be quickly removed from the luminaire assembly

without the need to disassemble the luminaire assembly itself. The luminaire assembly is composed of octagonal cast top and bottom rings and eight cast aluminum struts comprising the housing. The hinged lid is cast aluminum and is secured to the main housing by a stainless steel rotary latch.

DRIVER

The LED universal dimmable driver will be class 2 and capable of 120 - 277V or 347 - 480V input voltage, greater than 0.9 power factor, and less than 20% total harmonic distortion. The case temperature of the driver can range from -40°C to 70°C. Each LED system comes with a standard surge protection designed to withstand up to 20kV/10kA of transient line surge as per IEEE C62.41.2 C High. An in-line ferrite choke is utilized to provide protection against EFT's. Dimming capable using 1-10vdc (10% to 100%), 10v PWM, or resistance.

PHOTOMETRICS

Fixtures are tested to IESNA LM79 specifications. These reports are available upon request.

CHROMATICITY

High output LEDs come standard at 3000K & 4000K (+/- 300K) with a minimum nominal 70 CRI. Additional CCT emitters are available upon request.

LUMEN MAINTENANCE

Reported (TM21) and Calculated (L70) reports are available upon request with a minimum calculated value of 100,000 hrs.

WIRING

All internal wiring and connections shall be completed so that it will be necessary only to attach the incoming supply connectors to Mate-N-Lok connectors. Mate-N-Lok shall be certified for 600V operation. Internal wire connectors shall be crimp connector only and rated at 1000V and 150°C. All wiring to be CSA certified and/or UL listed, type SFF-2, SEWF-2, or SEW-2 No. 14 gauge, 150°C, 600V, and color coded for the required voltage.

THERMALS

Fixtures tested by a DOE sanctioned test facility to determine the maximum in-situ solder-point or junction-point temperatures of the LED emitters. This report is available upon request.

FINISH

Housing is finished with a 13 step KingCoat™ SuperDurable polyester TGIC powder coat. Standard colors include strobe white, brown metal, marina blue, gate gray, Chicago bronze, standard gold, standard black, federal green and rain forest. Please see our website for a complete list of colors. RAL and custom color matches are available.

MISCELLANEOUS

All exterior hardware and fasteners, wholly or partly exposed, shall be stainless-steel alloy. All internal fasteners are stainless-steel or zinc coated steel. All remaining internal hardware is stainless steel, aluminum alloy, or zinc coated steel.

WARRANTY

The K56 Cleveland/Tudor LED luminaire comes with a 7 year limited warranty.

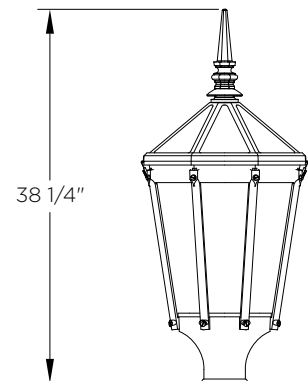

CERTIFICATION:

Suitable for wet locations
ISO 9001
IP66
ARRA Compliant
LM79 / LM80 Compliant
IDA Certified*

DRIVER INFO:

>0.9 Power Factor
<20% Total Harmonic Distortion
120 - 277V & 347 - 480V
-40°C Min. Case Temperature
70°C Max. Case Temperature
Surge Protection: ANSI C136.2
extreme level 20kV/10kA
Dimming Capable: 1-10vdc

EPA:

Cleveland
R Style - 2.86 sq. ft.
K5/K9 - 3.19 sq. ft.
K6/K9 - 3.26 sq. ft.
T Style - 2.87 sq. ft.
K24 - 3.49 sq. ft.
K16 - 3.35 sq. ft.

FIXTURE WEIGHT:

Cleveland
R Style - 41.9 lbs
K5/K9 - 43.8 lbs
K6/K9 - 48.0 lbs
T Style - 42.3 lbs
K24 - 52.5 lbs
K16 - 48.5 lbs



*DarkSky Certification applicable for maximum 3000K CCT.
Glass lenses do not apply.
Contact King Luminaire for product specifications that are exempt from CSA Certification.
04-15-2024

FIXTURE OPTIONS

K56 CLEVELAND/TUDOR - LED

Cleveland

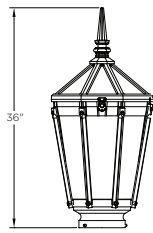

R-Style
7" OD Ring

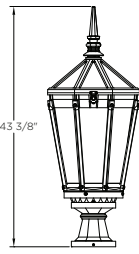

K5/K9
7" OD Ring

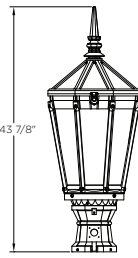

K6/K9
7" OD Ring

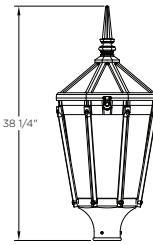

T-Style
3 1/2" Slipfitter

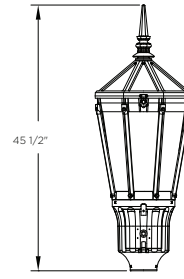

K24
3 1/2" Slipfitter

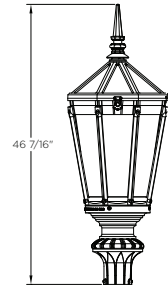

K16
3 1/2" Slipfitter

Tudor

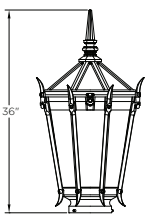

R-Style
7" OD Ring

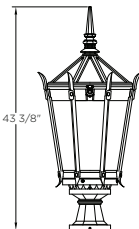

K5/K9
7" OD Ring

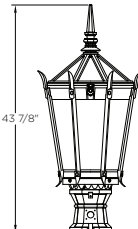

K6/K9
7" OD Ring

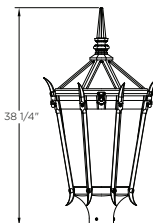

T-Style
3 1/2" Slipfitter

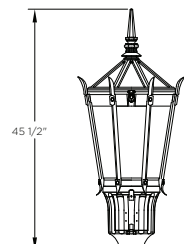

K24
3 1/2" Slipfitter

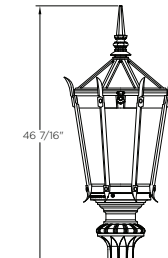

K16
3 1/2" Slipfitter

HOW TO ORDER

